



Solistic Panel Luminaires

Product Specifications



TCP's Solistic Panel Luminaires feature back-lit technology with a robust construction that still offers a slim, low-profile with beautiful full panel diffusion and superior uniformity.

TCP's Solistic line of LED products utilizes an advanced LED chip technology that mimics the natural appearance of sunlight without harsh UV or blue peaks found in most LED sources. This allows for reduced eye stress caused by harsh lighting while rendering exact colors. Proving to be better for your well-being, visibility, focus and sleep cycle, TCP believes that Solistic is Better for your Brain.™

Applications: T-bar Grid Ceilings

Reasons to choose the Solistic Panel Luminaires from TCP

- Unique LED chips utilized in Solistic products provide a more natural light appearance that mimics the sun
- Eliminates the blue peak found in other LED lighting sources
- Increased ability for users to focus and sleep
- Glare and flicker-free
- Mercury-free construction is great for all environments
- Fits standard 1" and 9/16" T-bar grid ceilings
- Utilizes back-lit technology for full diffusion with excellent uniformity
- Slim, low-profile design and lightweight for easy handling

Ideal Applications

- Office
- Retail Stores
- Schools
- Hospitality
- Restaurants
- Healthcare

Specifications

Input Line Voltage	120-277 VAC
Input Line Frequency (Hz)	50/60Hz
Wattage (W)	
1x4	23W/29W/38W
2x2	23W/29W/38W
2x4	29W/39W/46W
Lumens (L)	
1x4	2600L/3200L/4200L
2x2	2600L/3200L/4200L
2x4	3300L/4400L/5100L
Lumens per Watt (LPW).....	>110 LPW
Rated Life.....	50,000 hours
Minimum Starting Temperature	-20°C
Maximum Operating Temperature.....	40°C
CRI.....	>97
Power Factor	>90%
THD.....	<20%
Ratings.....	IC rated
Controls.....	0-10V dimming (standard)

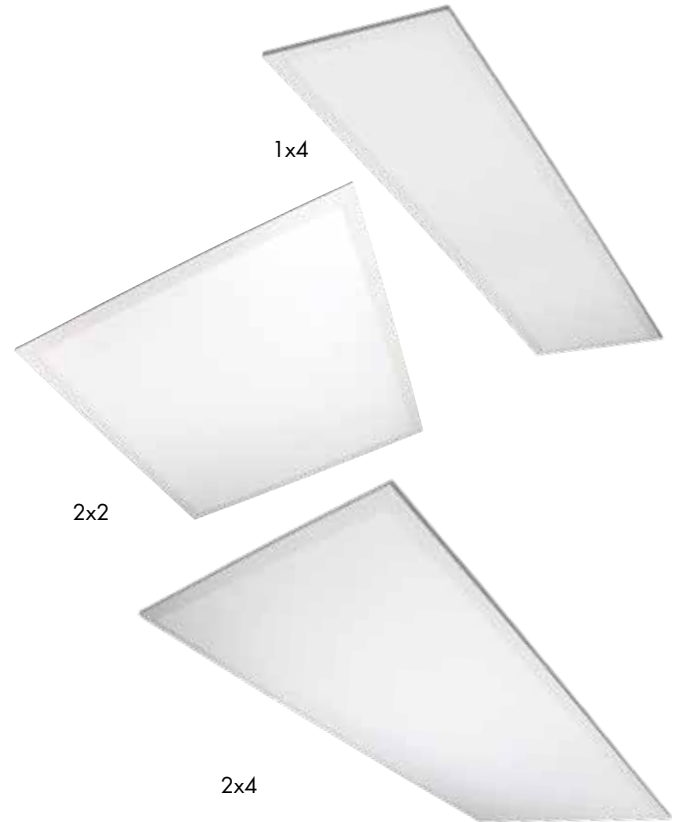

VS

LED Direct Troffer Luminaire

Spectrum imitates natural sunlight

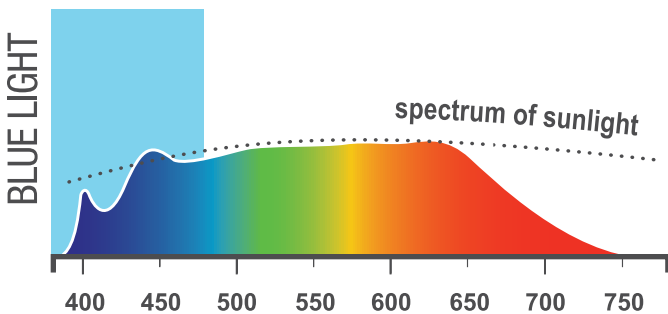

Spectrum of typical LED light

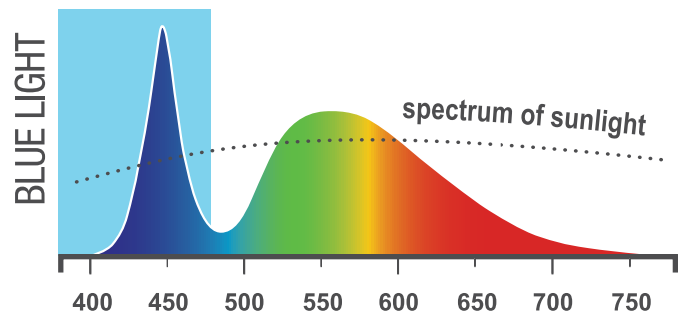

Applications

TCP Solistic Panel Luminaires are cost-effective, high-efficiency alternatives to traditional T5, T8 and T12 linear fluorescent troffers. Featuring a slim, low-profile design, our Solistic Panel Luminaires use back-lit technology to deliver full panel diffusion and superior uniformity that meets or exceeds the output from edge-lit panels. Applications include offices, schools, retail locations, healthcare, hospitality and other T-grid and commercial ceilings.

Construction

- Rectangular white frame
- Lens: frosted white diffuser
- IC rated for direct contact with insulation
- Designed for easy drop into T-bar grid ceilings

Electrical

- UL/cUL damp location rated
- 0-10V dimming driver (standard)
- LED driver with integrated junction box
- System rated for long 50,000 hour life

Optics

- Back-lit technology provides even, uniform lighting
- 120° beam angle
- Frosted diffuser for reduced glare and aesthetic appeal
- Meets or exceeds the look and performance of edge-lit panels

Item Number	
Notes	Type

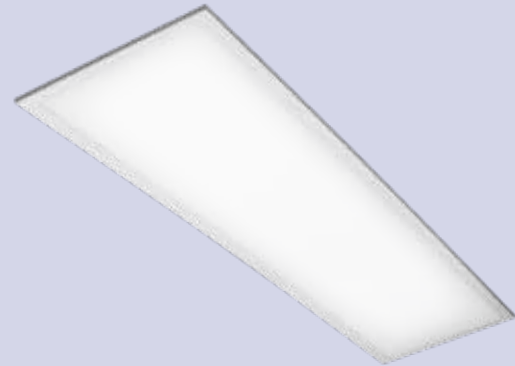

Listings

UL/cUL Listed
IC Rated
RoHS Compliant

Warranty

Five year limited warranty against defects in manufacturing.

Catalog Ordering Matrix Example: DTF1UZD2341S

FAMILY	LENS TYPE	SIZE	VOLTAGE	DIMMING	WATTAGE ^{1,2,3}	COLOR TEMPERATURE	OPTIONS
DT = Direct Back Lit Troffer	F = Frosted	1 = 1' x 4'	U = 120V-277V	ZD = 0-10V Dimming	23 = 2600 Lumens 29 = 3200 Lumens 38 = 4200 Lumens	41S = 4100K Solistic 50S = 5000K Solistic	EB = Battery Back-up

¹ Approximate lumen output. Actual performance may vary based on CCT, options selected and end user application.

² Actual wattage may differ by +/- 5%; when operating between 120-277V +/- 10%.

³ 23W and 29W are permanently fixed; 38W is adjustable to 29W or 23W.

Accessories:

Item Number	Description
YHANGER6PK	Y FIT CABLE HANGER 6 PACK (HANGS 3 UNITS)
DTSK1	SURFACE MOUNT KIT FOR 1X4 PANELS
DNFLK1	RECESS MOUNT FLANGE KIT FOR 1X4 PANELS

Specifications and dimensions subject to change without notice.

For the most up-to-date specs and warranty information, please visit www.tcpi.com

TCP®

325 Campus Dr. | Aurora, Ohio 44202 | P: 800-324-1496 | tcpi.com

5 YEAR
WARRANTY

Applications

TCP Solistic Panel Luminaires are cost-effective, high-efficiency alternatives to traditional T5, T8 and T12 linear fluorescent troffers. Featuring a slim, low-profile design, our Solistic Panel Luminaires use back-lit technology to deliver full panel diffusion and superior uniformity that meets or exceeds the output from edge-lit panels. Applications include offices, schools, retail locations, healthcare, hospitality and other T-grid and commercial ceilings.

Construction

- Rectangular white frame
- Lens: frosted white diffuser
- IC rated for direct contact with insulation
- Designed for easy drop into T-bar grid ceilings

Electrical

- UL/cUL damp location rated
- 0-10V dimming driver (standard)
- LED driver with integrated junction box
- System rated for long 50,000 hour life

Optics

- Back-lit technology provides even, uniform lighting
- 120° beam angle
- Frosted diffuser for reduced glare and aesthetic appeal
- Meets or exceeds the look and performance of edge-lit panels

Item Number	
Notes	Type

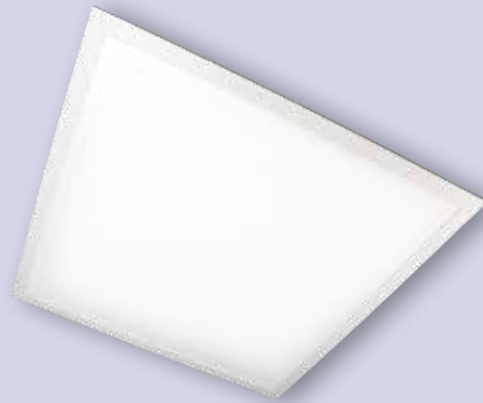

Listings

UL/cUL Listed
IC Rated
RoHS Compliant

Warranty

Five year limited warranty against defects in manufacturing.

Catalog Ordering Matrix Example: DTF2UZD2341S

FAMILY	LENS TYPE	SIZE	VOLTAGE	DIMMING	WATTAGE ^{1,2,3}	COLOR TEMPERATURE	OPTIONS
DT = Direct Back Lit Troffer	F = Frosted	2 = 2' x 2'	U = 120V-277V	ZD = 0-10V Dimming	23 = 2600 Lumens 29 = 3200 Lumens 38 = 4200 Lumens	41S = 4100K Solistic 50S = 5000K Solistic	EB = Battery Back-up

¹ Approximate lumen output. Actual performance may vary based on CCT, options selected and end user application.

² Actual wattage may differ by +/- 5%; when operating between 120-277V +/- 10%.

³ 23W and 29W are permanently fixed; 38W is adjustable to 29W or 23W.

Accessories:

Item Number	Description
YHANGER6PK	Y FIT CABLE HANGER 6 PACK (HANGS 3 UNITS)
DTSK2	SURFACE MOUNT KIT FOR 2X2 PANELS
DTFLK2	RECESS MOUNT FLANGE KIT FOR 2X2 PANELS

Specifications and dimensions subject to change without notice.

For the most up-to-date specs and warranty information, please visit www.tcp.com

TCP®

325 Campus Dr. | Aurora, Ohio 44202 | P: 800-324-1496 | tcp.com

5 YEAR
WARRANTY

Applications

TCP Solistic Panel Luminaires are cost-effective, high-efficiency alternatives to traditional T5, T8 and T12 linear fluorescent troffers. Featuring a slim, low-profile design, our Solistic Panel Luminaires use back-lit technology to deliver full panel diffusion and superior uniformity that meets or exceeds the output from edge-lit panels. Applications include offices, schools, retail locations, healthcare, hospitality and other T-grid and commercial ceilings.

Construction

- Rectangular white frame
- Lens: frosted white diffuser
- IP20 rated
- IC rated for direct contact with insulation
- Designed for easy drop into T-bar grid ceilings

Electrical

- UL/cUL damp location rated
- 0-10V dimming driver (standard)
- LED driver with integrated junction box
- System rated for long 50,000 hour life

Optics

- Back-lit technology provides even, uniform lighting
- 120° beam angle
- Frosted diffuser for reduced glare and aesthetic appeal
- Meets or exceeds the look and performance of edge-lit panels

Item Number	
Notes	Type

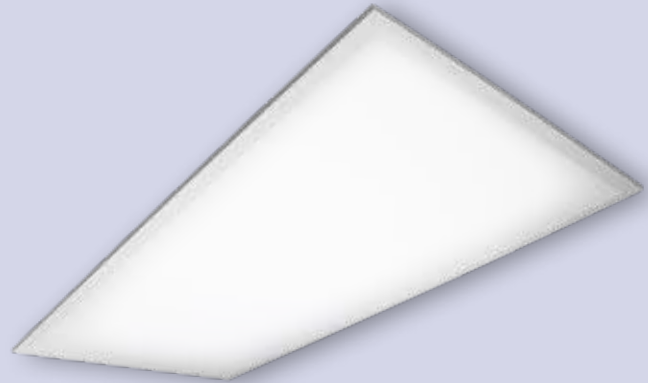

Listings

UL/cUL Listed
IC Rated
RoHS Compliant

Warranty

Five year limited warranty against defects in manufacturing.

Catalog Ordering Matrix Example: DTF4UZD2941S

FAMILY	LENS TYPE	SIZE	VOLTAGE	DIMMING	WATTAGE ^{1,2,3}	COLOR TEMPERATURE	OPTIONS
DT = Direct Back Lit Troffer	F = Frosted	4 = 2' x 4'	U = 120V-277V	ZD = 0-10V Dimming	29 = 3300 Lumens 39 = 4400 Lumens 46 = 5100 Lumens	41S = 4100K Solistic 50S = 5000K Solistic	EB = Battery Back-up

¹Approximate lumen output. Actual performance may vary based on CCT, options selected and end user application.

²Actual wattage may differ by +/- 5%; when operating between 120-277V +/- 10%.

³29W and 39W are permanently fixed; 46W is adjustable to 39W or 23W.

Accessories:

Item Number	Description
YHANGER6PK	Y FIT CABLE HANGER 6 PACK (HANGS 3 UNITS)
DTSK4	SURFACE MOUNT KIT FOR 2X4 PANELS
DNFLK4	RECESS MOUNT FLANGE KIT FOR 2X4 PANELS

Specifications and dimensions subject to change without notice.

For the most up-to-date specs and warranty information, please visit www.tcpi.com

1x4 Dimensions

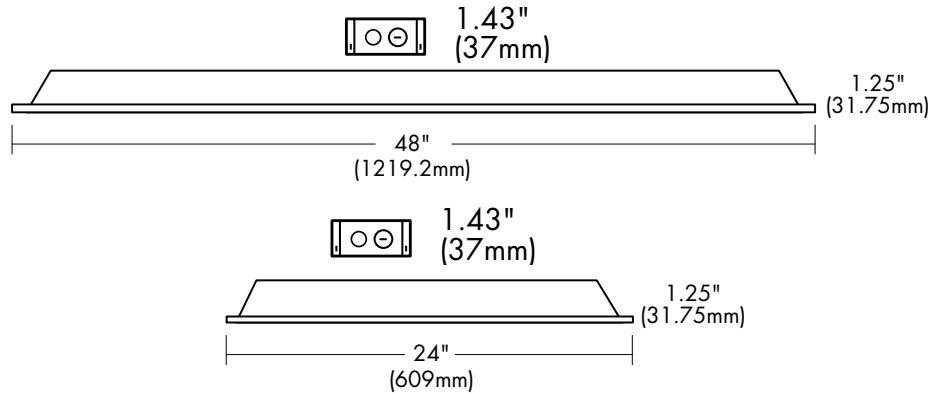

2x2 Dimensions

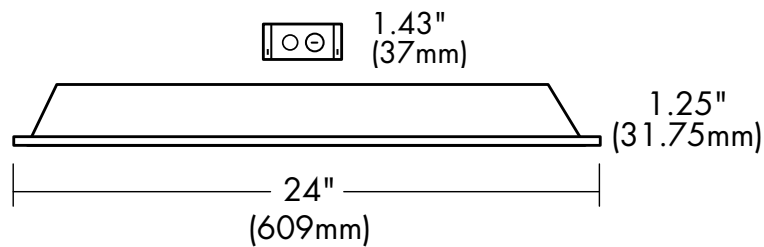

2x4 Dimensions

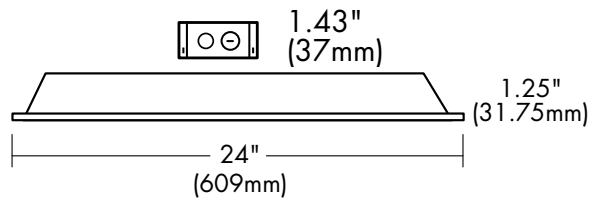
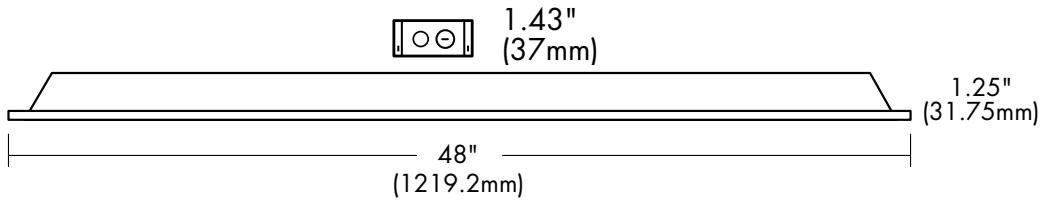

TECHNOLOGY CAST IN A BEAUTIFUL LIGHT

For over 30 years, TCP has been designing, developing and delivering energy-efficient lighting into the market. Thanks to our cutting-edge technology and manufacturing expertise, we have shipped billions of high quality lighting products. With TCP, you can count on a lighting product that is designed to meet the needs of the market - that transforms your surroundings and envelopes you in warmth - lighting that generates beauty with every flip of the switch.

For more information on the quality and care TCP can deliver, call us at **800.324.1496** or visit tcp.com

325 Campus Dr. | Aurora, Ohio 44202 | P: 800-324-1496 | F: 877-487-0516