



# USER'S MANUAL

## SMOKE & CARBON MONOXIDE ALARM

10-YEAR SEALED BATTERY WITH VOICE & LOCATION

Model SMC0210V

**IMPORTANT! PLEASE READ CAREFULLY AND SAVE.**  
The warnings/limitations card and manual contains important information about your Smoke Alarm's operation. If you are installing this Alarm for use by others, you must leave this manual—or a copy of it—with the end user.  
**Para el manual del usuario en español, por favor visite firstalert.com**

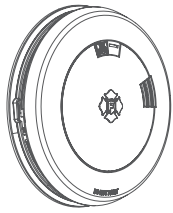

### RECOMMENDED PLACEMENT:



**Smoke Alarm**  
One on every level and in every bedroom

**Carbon Monoxide Alarm**  
One on every level and in every bedroom

**Fire Extinguisher**  
One on every level, plus kitchen and garage

- When installing on the wall, the top edge of Smoke Alarms should be placed between 4 inches (102 mm) and 12 inches (305 mm) from the wall/ceiling line.
- When installing on the ceiling, place the Alarm as close to the center as possible.
- In either case, install at least 4 inches (102 mm) from where the wall and ceiling meet. See "Avoiding Dead Air Spaces" for more information.

**NOTE:** For any location, make sure no door or other obstruction could keep carbon monoxide or smoke from reaching the Alarm.

### WHERE NOT TO INSTALL THIS ALARM

#### FOR BEST PERFORMANCE, IT IS RECOMMENDED YOU AVOID INSTALLING SMOKE/CO ALARMS IN THESE AREAS:

- In garages, furnace rooms, crawl spaces and unfinished attics. Avoid extremely dusty, dirty or greasy areas.
- Where combustion particles are produced. Combustion particles form when something burns. Areas to avoid include poorly ventilated kitchens, garages, and furnace rooms. Keep units at least 20 feet (6 meters) from the sources of combustion particles (stove, furnace, water heater, space heater) if possible. In areas where a 20-foot (6 meter) distance is not possible – in modular, mobile, or smaller homes, for example – it is recommended the Smoke Alarm be placed as far from these fuel-burning sources as possible. The placement recommendations are intended to keep these Alarms at a reasonable distance from a fuel-burning source, and thus reduce "unwanted" Alarms. Unwanted Alarms can occur if a Smoke Alarm is placed directly next to a fuel-burning source. Ventilate these areas as much as possible.
- Within 5 feet (1.5 meters) of any cooking appliance. In air streams near kitchens. Air currents can draw cooking smoke into the smoke sensor and cause unwanted Alarms.
- In extremely humid areas. This Alarm should be at least 10 feet (3 meters) from a shower, sauna, humidifier, vaporizer, dishwasher, laundry room, utility room, or other source of high humidity.
- In direct sunlight.
- In turbulent air, like near ceiling fans or open windows. Blowing air may prevent CO or smoke from reaching the sensors.
- In areas where temperature is colder than 40° F (4.4° C) or hotter than 100° F (37.8° C). These areas include non-air conditioned crawl spaces, unfinished attics, uninsulated or poorly insulated ceilings, porches, and garages.
- In insect infested areas. Insects can clog the openings to the sensing chamber.
- Less than 12 inches (305 mm) away from fluorescent lights. Electrical "noise" can interfere with the sensor.
- In "dead air" spaces.

### AVOIDING DEAD AIR SPACES

"Dead air" spaces may prevent smoke from reaching the Smoke Alarm. To avoid dead air spaces, follow installation recommendations below.

**On ceilings,** install Smoke Alarms as close to the center of the ceiling as possible. If this is not possible, install the Smoke Alarm at least 4 inches (102 mm) from the wall or corner.

**For wall mounting** (if allowed by building codes), the top edge of Smoke Alarms should be placed between 4 inches (102 mm) and 12 inches (305 mm) from the wall/ceiling line, below typical "dead air" spaces.

**On a peaked, gabled, or cathedral ceiling,** install the first Smoke Alarm within 3 feet (0.9 meters) of the peak of the ceiling, measured horizontally. Additional Smoke Alarms may be required depending on the length, angle, etc. of the ceiling's slope. Refer to NFPA 72 for details on requirements for sloped or peaked ceilings.

### HOW TO INSTALL THIS ALARM

#### IMPORTANT!

**This combination Smoke/CO Alarm was designed to be mounted on the ceiling or wall. It is not a tabletop device. You must install this device on the ceiling or wall as outlined below. Read "Where To Install This Alarm" before starting.**

This unit is designed to be mounted on the ceiling, or on the wall if necessary.

**Tools you will need: pencil, drill with 3/16" (5 mm) drill bit, standard flathead screwdriver, hammer**

#### THE PARTS OF THIS SMOKE/CO ALARM

- Test/Silence button
- Dual power indicator light and Alarm indicator: Green LED provides visual indication of an Alarm memory condition; Red LED provides visual indication of an Alarm and hush modes
- Speaker
- Turn this way to remove
- Turn this way to attach
- Mounting bracket
- Mounting slots

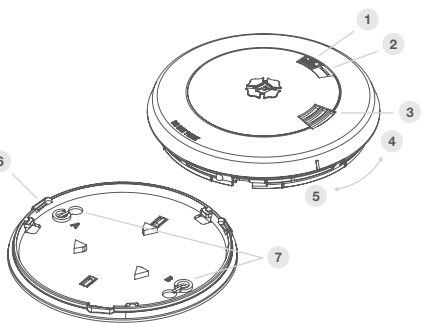

#### FOLLOW THESE SIMPLE STEPS

- Choose a location. See "Where to Install This Alarm" for reference. **WARNING! Do not install this Alarm over an existing electrical box. Only AC powered units are intended for installation over electrical boxes.**
- Mark hole locations 4-1/4" apart. Use the mounting bracket to verify the hole mark locations are accurately spaced. If mounting on the wall, holes must be aligned horizontally to ensure Alarm is mounted upright. Put the Alarm where it won't get covered with dust while you drill the holes. Using a 3/16" (5 mm) drill bit, drill a hole through the marks you made for the mounting holes.
- Using a 3/16" (5 mm) drill bit, drill a hole through the marks you made for the mounting holes.
- Insert the plastic screw anchors (in the plastic bag with screws) into the holes. Tap the screw anchors gently with a hammer, if necessary, until they are flush with the ceiling or wall.
- Insert the screws but do not tighten completely. Leave them about 1/4" (6mm) away from the wall. Attach the mounting bracket to the wall or ceiling by aligning the round part of the slots with the screws. To mount on a wall, align the hole marked A with the left screw. Rotate the bracket until the screws are completely inside the raised portion of the circular recesses (see image). Once the screws are completely inside the raised portion of the circular recesses, tighten the screws until they are snug to secure the bracket. Do not over-tighten the screws.
- Activating the battery. Mount Alarm to mounting bracket to activate. Alarm will be oriented as shown. Once unit is activated, it cannot be turned off. Make sure the Alarm is locked into the mounting bracket. **NOTE:** After you activate the battery, there may be Power and LED activation indicators.
- Test the Alarm. See "Weekly Testing."

#### Mounting Hole Sets

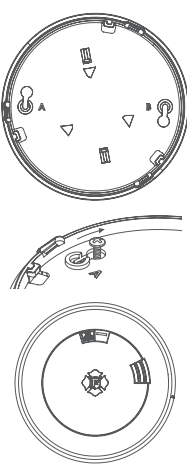

### STEP BY STEP GUIDE TO PROGRAMMING THIS ALARM

For First Time

| Action   | Alarm Will Say  |
|--|---|
| Activate Alarm.  | "Welcome, First Alert carbon monoxide and Smoke Alarm."<br>"No location programmed" if first time or "[Location, example: 'Hallway'] location programmed" when changing batteries.<br>"To select location, press and hold test button now." |
| Press & hold test button if you would like to program the location or change the location of the Alarm. Release button after Alarm responds. | "To save location, press and hold test button after location is heard."<br>Alarm will speak list of locations (see below).  |
| After you hear the location of where you are placing the Alarm, Press & hold the test Button.  | "[Location, example: "Hallway"] location saved."<br>If no location is chosen: "No location saved."  |

Your Alarm has now been programmed for the location of your choice.

**Available locations:** Basement, Hallway, Office, Child's Bedroom, Kitchen, Utility Room, Dining Room, Living Room, Family Room, Master Bedroom, Guest Bedroom, No Location

**For reprogramming:** When it is necessary to reprogram the Alarm after the unit has been activated and is in normal operation: Tap the test button 5 times to reset the Alarm to again access the programming menu.

| Action   | What You Will See & Hear  |
|--|---|
| <b>Under Normal Operations</b>                                 | <b>Voice:</b> Silent; <b>Horn:</b> Silent; <b>Power LED:</b> Flashes Green once a minute  |
| <b>When You Test the Alarm</b>                                 | A "chirp" and then <b>Voice:</b> "Testing." "Warning, evacuate smoke in [Location, example: "Hallway"]. Evacuate."; <b>Horn:</b> 3 beeps, pause, 3 beeps, voice; <b>Power LED:</b> Flashes Red followed by <b>Voice:</b> "Warning, evacuate carbon monoxide in [Location, example: "Hallway"]. Evacuate."; <b>Horn:</b> 4 beeps, pause, 4 beeps, voice; <b>Power LED:</b> Flashes Red |
| <b>If Alarm is Not Operating Properly (MALFUNCTION SIGNAL)</b> | <b>Voice:</b> "Detector error in [Location, example "Hallway"], please see manual." Repeated every 5 hours; <b>Horn:</b> 3 chirps every minute; <b>Power LED:</b> Three Green flashes approximately once a minute   |
| <b>If Battery Becomes Low</b>                                  | <b>Voice:</b> "Detector Error in [Location, example "Hallway"], please see manual." Repeated every 5 hours; <b>Horn:</b> 5 chirps every minute; <b>Power LED:</b> One green flash approximately every minute  |
| <b>Alarm has reached its End of Life</b>                       | <b>Voice:</b> "Detector error in [Location, example "Basement"], please see manual." Repeated every 5 hours; <b>Horn:</b> 5 chirps every minute; <b>Power LED:</b> Five Green flashes approximately once a minute   |
| <b>Alarm Levels of CO are Detected</b>                         | <b>Voice:</b> "Warning, evacuate carbon monoxide in [Location, example: "Hallway"]. Evacuate." " ____ ppm."; <b>Horn:</b> 4 beeps, pause, 4 beeps, voice; <b>Power LED:</b> Flashes Red   |
| <b>Smoke is Detected</b>                                       | <b>Voice:</b> "Warning, evacuate smoke in [Location, example: "Hallway"]. Evacuate."; <b>Horn:</b> 3 beeps, pause, 3 beeps, voice; <b>Power LED:</b> Flashes Red  |
| <b>Smoke Alarm is Silenced</b>                                 | <b>Voice:</b> Silent; <b>Horn:</b> Off; <b>Power LED:</b> Flashes Red   |
| <b>CO Alarm is Silenced</b>                                    | <b>Voice:</b> Silent; <b>Horn:</b> Off; <b>Power LED:</b> Flashes Red   |

## 04 ALARM FEATURES

- Voice & Location Alerts:** Friendly voice tells you what the danger is and it's location.
- No Battery Replacements:** For the life of the Alarm.
- End of Life Warning:** Let's you know when it's time to replace.

### OPTIONAL LOCKING FEATURE

The optional locking feature is designed to prevent unauthorized removal of the Alarm. It is not necessary to activate the lock in single-family households where unauthorized Alarm removal is not a concern.

**Tools you will need:** Needle-nose pliers or utility knife, standard flathead screwdriver

The feature uses a locking pin which is molded into the mounting bracket. Remove locking pin by using needle-nose pliers or a utility knife.

#### IMPORTANT!

**To permanently remove the locking pin, insert a flathead screwdriver between the locking pin and the lock and pry the pin out of the lock.**

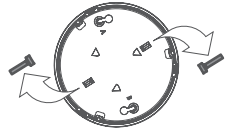

### TO LOCK THE MOUNTING BRACKET

- Using needle-nose pliers, detach the pin from the mounting bracket.
- Insert the locking pin through the hole on the back of the Smoke Alarm as shown in the diagram.
- When you attach the Alarm to the mounting bracket the locking pin's head will fit into a notch on the bracket.

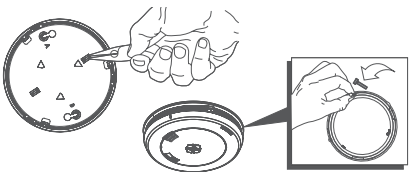

### TO UNLOCK THE MOUNTING BRACKET

- Insert a flathead screwdriver in between the mounting bracket and the locking pin.
- Pry the Alarm away from the bracket by pushing up the screwdriver and turning the Alarm counterclockwise (left) at the same time.

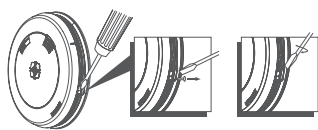

### HOW TO PERMANENTLY DEACTIVATE THE SMOKE ALARM

After Malfunction, 10 years of Operation Low Battery or End of Life Warnings, deactivate the Alarm: Insert a tool below edge where shown and break tab. Then slide activation switch to deactivate mode.

**NOTE:** At end of life (chirp): unit must be put into deactivation mode to deactivate remaining stored energy in battery. Unit will no longer function once put into this mode. Unit will resist re-mounting.

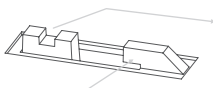

## 05 TESTING & MAINTENANCE

### WEEKLY TESTING

#### ▲ WARNING!

- NEVER** use an open flame of any kind to test this unit. You might accidentally damage or set fire to the unit or to your home. **NEVER** use vehicle exhaust! Exhaust may cause permanent damage and voids your warranty.
- DO NOT** stand close to the Alarm when the horn is sounding. Exposure at close range may be harmful to your hearing. When testing, step away when horn starts sounding.

#### ▲ CAUTION!

**It is important to test this unit every week to make sure it is working properly. Using the test button is the recommended way to test this Smoke/CO Alarm.**

**You can test this Smoke/CO Alarm** by pressing and holding the Test/Silence button on the Alarm cover until Alarm Voice says "Testing" (typically 3-5 seconds). During testing, you will see and hear the following sequence:

- The **Alarm Voice** will say "Testing." The **Horn** will sound 3 beeps, pause, 3 beeps. The Alarm Voice will say "Warning, evacuate smoke in [Location, example: "Hallway"]. Evacuate." The Power LED flashes Red.
- Next the Horn will sound 4 beeps, pause, 4 beeps. The Alarm Voice will say "Warning, evacuate carbon monoxide in [Location, example: "Hallway"]. Evacuate." The LED flashes Red.

**If the unit does not Alarm, make sure the batteries are correctly installed, and test again. If the unit still does not Alarm, replace it immediately.**

### REGULAR MAINTENANCE

This unit has been designed to be as maintenance free as possible, but there are a few simple things you must do to keep it working properly.

- Test it at least once a week.
- Clean the Smoke/CO Alarm at least once a month; gently vacuum the outside of the Smoke/CO Alarm using your household vacuum's soft brush attachment. A can of clean compressed air (sold at computer or office supply stores) may also be used. Follow manufacturer instructions for use. Test the Smoke/CO Alarm. Never use water, cleaners or solvents since they may damage the unit.
- If the Smoke/CO Alarm becomes contaminated by excessive dirt, dust and/or grime, and cannot be cleaned to avoid unwanted Alarms, replace the unit immediately.
- If the green power LED flashes 2 times every minute (horn is silent) it means that the Alarm needs to be cleaned as indicated above. If green light continues to flash, replace Alarm.
- Relocate the unit if it sounds frequent unwanted Alarms. See "Where This Alarm Should Not Be Installed" for details.
- Protect or cover the alarm when doing any maintenance to home i.e. sanding floors, painting, drywall patching, etc. to prevent contamination.

#### IMPORTANT!

Actual battery service life depends on the Smoke/CO Alarm and the environment in which it is installed. Alarm is sealed with no serviceable parts. Battery is not replaceable. You MUST replace the Alarm immediately once it starts "chirping" (the "End of Life Low Battery warning").

### TROUBLESHOOTING GUIDE

| IF THE ALARM...   | PROBLEM...   | YOU SHOULD...   |
|---|--|---|
| <b>Horn</b> sounds 3 "chirps" every minute; <b>Voice:</b> "Detector error in [Location, example "Hallway"], please see manual" repeated every 5 hours; <b>LED</b> has 3 Green flashes with "chirps".    | <b>MALFUNCTION SIGNAL.</b> Device is not working properly, and needs to be replaced. | If unit is under warranty, contact Consumer Support to process a warranty replacement.  |
| <b>Horn</b> sounds 5 chirps every minute; <b>Voice:</b> Detector error in [Location, example "Hallway"], please see manual" repeated every 5 hours; <b>LED</b> has one Green flash approx every minute. | Low Battery Signal. Alarm needs to be replaced.                                      | Immediately replace the Alarm.  |
| The <b>light</b> flashes GREEN and the <b>horn</b> sounds 5 "chirps" every minute; <b>Voice:</b> "Detector error in [Location, example "Basement"], please see manual." Repeated every 5 hours.         | <b>END OF LIFE SIGNAL.</b> Alarm needs to be replaced.                               | Immediately replace the Alarm.  |
| Power LED flashes Green 2 times every minute.   | Alarm requires cleaning.   | Clean Alarm then press and release the test button. See Regular Maintenance section. If Green LED Continues to flash, contact Consumer Support. |

### CARBON MONOXIDE ALARM ONLY

|   |   |   |
|---|---|---|
| CO Alarm goes back into Alarm 4 minutes after you silence it.                                 | CO levels indicate a potentially dangerous situation.                                       | <b>IF YOU ARE FEELING SYMPTOMS OF CO POISONING, EVACUATE</b> your home and call 911 or the Fire Department. Refer to "If The CO Alarm Sounds" for details.  |
| CO Alarm sounds frequently even though no high levels of CO are revealed in an investigation. | The CO Alarm may be improperly located. Refer to "Where to Install This Alarm" for details. | Relocate your Alarm. If frequent Alarms continue, have home rechecked for potential CO problems. You may be experiencing an intermittent CO problem.  |
| Smoke Alarm sounds when no smoke is visible.  | Unwanted Alarm may be caused by nonemergency source like cooking smoke.                     | Silence Alarm using Test/Silence button; clean the Alarm's cover with a soft, clean cloth. If frequent unwanted Alarms continue, relocate your Alarm. Alarm may be too close to a kitchen, cooking appliance, or steamy bathroom. |

If you have questions that cannot be answered by reading this manual, call the Consumer Support Team at 1-800-323-9005

### FIRE SAFETY TIPS

Follow safety rules and prevent hazardous situations: 1) Use smoking materials properly. Never smoke in bed. 2) Keep matches or lighters away from children; 3) Store flammable materials in proper containers; 4) Keep electrical appliances in good condition and don't overload electrical circuits; 5) Keep stoves, barbecue grills, fireplaces and chimneys grease- and debris-free; 6) Never leave anything cooking on the stove unattended; 7) Keep portable heaters and open flames, like candles, away from flammable materials; 8) Don't let rubbish accumulate. Keep Alarms clean, and test them weekly. Replace Alarms immediately if they are not working properly. Smoke Alarms that do not work cannot alert you to a fire. Keep at least one working fire extinguisher on every level, and an additional one in the kitchen. Have fire escape ladders or other reliable means of escape from an upper level in case stairs are blocked; 9) Have an escape plan and practice it regularly.

## 06 IF YOUR SMOKE/GO ALARM SOUNDS

### WHAT TO DO FIRST—IDENTIFY THE TYPE OF ALARM SIGNAL

| Type of Alarm               | What You Will See & Hear  |
|-----------------------------|---|
| <b>Carbon Monoxide (CO)</b> | <b>Voice:</b> "Warning, evacuate carbon monoxide in [Location, example: "Hallway"]. Evacuate." " ____ ppm."; <b>Horn:</b> 4 beeps, pause, 4 beeps, voice; <b>LED:</b> Flashes Red |
| <b>Smoke</b>                | <b>Voice:</b> "Warning, evacuate smoke in [Location, example: "Hallway"]. Evacuate."; <b>Horn:</b> 3 beeps, pause, 3 beeps, voice; <b>LED:</b> Flashes Red                        |

## IF THE CO ALARM SOUNDS

|                                  |   |
|----------------------------------|---|
| <b>"ALARM-MOVE TO FRESH AIR"</b> | If you hear the CO Alarm horn and the CO red light is flashing, move everyone to a source of fresh air. <b>DO NOT</b> remove the batteries! |
|----------------------------------|---|

### ▲ WARNING!

**Actuation of your CO Alarm indicates the presence of carbon monoxide (CO) which can kill you. In other words, when your CO Alarm sounds, you must not ignore it!**

**IF THE CO ALARM SIGNAL SOUNDS:**

- Press the Test/Silence button.
- Call your emergency services, fire department or 911. Write down the number of your local emergency service here:
- Immediately move to fresh air—outdoors or by an open door or window. Do a head count to check that all persons are accounted for. Do not re-enter the premises, or move away from the open door or window until the emergency services responder has arrived, the premises have been aired out, and your CO Alarm remains in its normal condition.
- After following steps 1-3, if your CO Alarm reactivates within a 24-hour period, repeat steps 1-3 and call a qualified appliance technician to investigate for sources of CO from fuel-burning equipment and appliances, and inspect for proper operation of this equipment. If problems are identified during this inspection have the equipment serviced immediately. Note any combustion equipment not inspected by the technician, and consult the manufacturers' instructions, or contact the manufacturers directly, for more information about CO safety and this equipment. Make sure that motor vehicles are not, and have not, been operating in an attached garage or adjacent to the residence. Write down the number of a qualified appliance technician here:

**NOTE:** A qualified appliance technician is defined as "a person, firm, corporation, or company that either in person or through a representative, is engaged in and responsible for the installation, testing, servicing, or replacement of heating, ventilation, air conditioning (HVAC) equipment, combustion appliances and equipment, and/or gas fireplaces or other decorative combustion equipment."

|  |   |
|--|---|
| <b>AFTER AN ALARM</b><br><b>After the emergency responders arrive, the premises aired out, and your CO Alarm remains in its normal condition, you can check what the highest carbon monoxide level sensed was:</b> |   |
| Action   | Alarm Will Say  |
| Press & Hold Test Button   | "Highest carbon monoxide level was ____ ppm. Please see manual.," "To clear highest carbon monoxide level, press and hold test button now." |
| Press & Hold Test Button, if you would like to clear the highest level sensed. If you would like to keep the highest level in memory, do not press anything.   | "Highest carbon monoxide level cleared." Alarm will say nothing.  |

## IF THE SMOKE ALARM SOUNDS: RESPONDING TO AN ALARM

### ▲ WARNING!

- If the unit Alarms and you are not testing the unit, it is warning you of a potentially dangerous situation that requires your immediate attention. **NEVER** ignore any Alarm. Ignoring the Alarm may result in injury or death.
- Never remove the batteries from a battery operated Smoke/CO Alarm to stop an unwanted Alarm (caused by cooking smoke, etc.). Removing batteries disables the Alarm so it cannot sense smoke, and removes your protection. Instead open a window or fan the smoke away from the unit. The Alarm will reset automatically.
- If the unit Alarms get everyone out of the house immediately.

### WHAT TO DO IN CASE OF FIRE

- Don't panic; stay calm. Follow your family escape plan.
- Get out of the house as quickly as possible. Don't stop to get dressed or collect anything.
- Feel doors with the back of your hand before opening them. If a door is cool, open it slowly. Don't open a hot door. Keep doors and windows closed, unless you must escape through them.
- Cover your nose and mouth with a cloth (preferably damp). Take short, shallow breaths.
- Meet at your planned meeting place outside your home, and do a head count to make sure everybody got out safely.
- Call the Fire Department as soon as possible from outside. Give your address, then your name.
- Never go back inside a burning building for any reason.
- Contact your Fire Department for ideas on making your home safer.

### ▲ WARNING!

Alarms have various limitations. See "General Limitations of Smoke/CO Alarms" for details.

## 07 USING THE SILENCE FEATURES

### ▲ WARNING!

**Never deactivate the unit to quiet an unwanted Alarm. Deactivating the Alarm disables the unit and removes your protection.**

The Silence Feature is intended to temporarily silence the horn while you identify and correct the problem. Do not use the Silence Feature in emergency situations. It will not correct a CO problem or extinguish a fire.

The Silence Feature can temporarily quiet an unwanted Alarm for several minutes. You can silence this Smoke/CO Alarm by pressing the Test/Silence button on the Alarm cover for at least 3-5 seconds. After the Test/Silence button is released, the Red LED blinks during the silence mode. Activate the Alarm test, reset or silence function by use of a finger or thumb. Use of any other instrument is strictly prohibited.

|   |  |
|---|--|
| <b>When the Smoke Alarm is Silenced</b>   | <b>When the CO Alarm is Silenced</b>   |
| The Smoke Alarm will remain silent for up to 15 minutes, then return to normal operation. | The CO Alarm will remain silent for up to 4 minutes.   |
| If the smoke has not cleared–or continues to increase–the device will go back into Alarm. | After 4 minutes, if CO levels remain potentially dangerous the horn will start sounding again. |

### SILENCING THE END OF LIFE SIGNAL

This Silence Feature can temporarily quiet the End of Life warning "chirp" for up to 2 days. You can silence the End of Life warning "chirp" by pressing the Test/Silence button. The horn will chirp, acknowledging that the End of Life Silence Feature has been activated. After approximately 2 days, the End of Life "chirp" will resume.

## 08 WHAT YOU NEED TO KNOW ABOUT CO

### WHAT IS CO?

CO is an invisible, odorless, tasteless gas produced when fossil fuels do not burn completely, or are exposed to heat (usually fire). Electrical appliances typically do not produce CO.

**These fuels include:** Wood, coal, charcoal, oil, natural gas, gasoline, kerosene, and propane.

Common appliances are often sources of CO. If they are not properly maintained, are improperly ventilated, or malfunction, CO levels can rise quickly. CO is a real danger now that homes are more energy efficient. "Airtight" homes with added insulation, sealed windows, and other weatherproofing can "trap" CO inside.

### SYMPTOMS OF CO POISONING

These symptoms are related to CO POISONING and should be discussed with ALL household members.

**Mild Exposure:** Slight headache, nausea, vomiting, fatigue ("flu-like" symptoms).

**Medium Exposure:** Throbbing headache, drowsiness, confusion, fast heart rate.

**Extreme Exposure:** Convulsions, unconsciousness, heart and lung failure. Exposure to carbon monoxide can cause brain damage, death.

### IMPORTANT!

This CO Alarm measures exposure to CO over time. It Alarms if CO levels are extremely high in a short period of time, or if CO levels reach a certain minimum over a long period of time. The CO Alarm generally sounds an Alarm before the onset of symptoms in average, healthy adults. Why is this important? Because you need to be warned of a potential CO problem while you can still react in time. In many reported cases of CO exposure, victims may be aware that they are not feeling well, but become disoriented and can no longer react well enough to exit the building or get help. Also, young children and pets may be the first affected. The average healthy adult might not feel any symptoms when the CO Alarm sounds. However, people with cardiac or respiratory problems, infants, unborn babies, pregnant mothers, or elderly people can be more quickly and severely affected by CO. If you experience even mild symptoms of CO poisoning, consult your doctor immediately!

### FINDING THE SOURCE OF CO AFTER AN ALARM

Carbon monoxide is an odorless, invisible gas, which often makes it difficult to locate the source of CO after an Alarm. These are a few of the factors that can make it difficult to locate sources of CO:

- House well ventilated before the investigator arrives.
- Problem caused by "backdrafting."
- Transient CO problem caused by special circumstances.

**Because CO may dissipate by the time an investigator arrives, it may be difficult to locate the source of CO. First Alert shall not be obligated to pay for any carbon monoxide investigation or service call.**

### POTENTIAL SOURCES OF CO IN THE HOME

**Fuel-burning appliances like:** portable heater, gas or wood burning fireplace, gas kitchen range or cooktop, gas clothes dryer.

**Damaged or insufficient venting:** corroded or disconnected water heater vent pipe, leaking chimney pipe or flue, or cracked heat exchanger, blocked or clogged chimney opening.

**Improper use of appliance/device:** operating a barbecue grill or vehicle in an enclosed area (like a garage or screened porch).

**Transient CO Problems:** "transient" or on-again-off-again CO problems can be caused by outdoor conditions and other special circumstances.

**THE FOLLOWING CONDITIONS CAN RESULT IN TRANSIENT CO SITUATIONS:**

- Excessive spillage or reverse venting of fuel appliances caused by outdoor conditions such as:
  - Wind direction and/or velocity, including high, gusty winds. Heavy air in the vent pipes (cold/humid air with extended periods between cycles).
  - Negative pressure differential resulting from the use of exhaust fans.
  - Several appliances running at the same time competing for limited fresh air.
  - Vent pipe connections vibrating loose from clothes dryers, furnaces, or water heaters.
  - Obstructions in or unconventional vent pipe designs which can amplify the above situations.
- Extended operation of unvented fuel burning devices (range, oven, fireplace).
- Temperature inversions, which can trap exhaust close to the ground.
- Car idling in an open or closed attached garage, or near a home.

**These conditions are dangerous because they can trap exhaust in your home. Since these conditions can come and go, they are also hard to recreate during a CO investigation.**

### HOW CAN I PROTECT MY FAMILY FROM CO POISONING?

A CO Alarm is an excellent means of protection. It monitors the air and sounds a loud Alarm before carbon monoxide levels become threatening for average, healthy adults. A CO Alarm is not a substitute for proper maintenance of home appliances.

### TO HELP PREVENT CO PROBLEMS AND REDUCE THE RISK OF CO POISONING:

- Clean chimneys and flues yearly. Keep them free of debris, leaves, and nests for proper air flow. Also, have a professional check for rust and corrosion, cracks, or separations. These conditions can prevent proper air movement and cause backdrafting. Never "cap" or cover a chimney in any way that would block air flow.
- Test and maintain all fuel-burning equipment annually. Many local gas or oil companies and HVAC companies offer appliance inspections for a nominal fee.
- Make regular visual inspections of all fuel-burning appliances. Check appliances for excessive rust and scaling. Also check the flame on the burner and pilot lights. The flame should be blue. A yellow flame means fuel is not being burned completely and CO may be present. Keep the blower door on the furnace closed. Use vents or fans when they are available on all fuel-burning appliances. Make sure appliances are vented to the outside. Do not grill or barbecue indoors, or in garages or on screen porches.
- Check for exhaust backflow from CO sources. Check the draft hood on an operating furnace for a backdraft. Look for cracks on furnace heat exchangers.
- Check the house or garage on the other side of shared wall.
- Keep windows and doors open slightly. If you suspect that CO is escaping into your home, open a window or a door. Opening windows and doors can significantly decrease CO levels.

In addition, familiarize yourself with all enclosed materials. Read this manual in its entirety, and make sure you understand what to do if your CO Alarm sounds.

## 09 REGULATORY INFORMATION FOR SMOKE ALARMS

### RECOMMENDED LOCATIONS FOR SMOKE ALARMS INSTALLING SMOKE ALARMS IN SINGLE-FAMILY RESIDENCES

The National Fire Protection Association (NFPA), recommends one Smoke Alarm on every level, in every sleeping area, and in every bedroom. In new construction, the Smoke Alarms must be AC powered and interconnected. See "Agency Placement Recommendations" for details. For additional coverage, it is recommended that you install a Smoke Alarm in all rooms, halls, storage areas, finished attics, and basements, where temperatures normally remain between 40° F (4.4° C) and 100° F (37.8° C). Make sure no door or other obstruction could keep smoke from reaching the Smoke Alarms.

### MORE SPECIFICALLY, INSTALL SMOKE ALARMS:

- On every level of your home, including finished attics and basements.
- Inside every bedroom, especially if people sleep with doors closed.
- In the hall near every sleeping area. If your home has multiple sleeping areas, install a unit in each. If a hall is over 40 feet (12 meters) long, install an Alarm at each end.
- At the top of the first-to-second level stairway, and at bottom of basement stairway.

### IMPORTANT!

Specific requirements for Smoke Alarm installation vary from state to state and from region to region. Check with your local Fire Department for current requirements in your area. **It is recommended AC or AC/DC units be interconnected for added protection.**

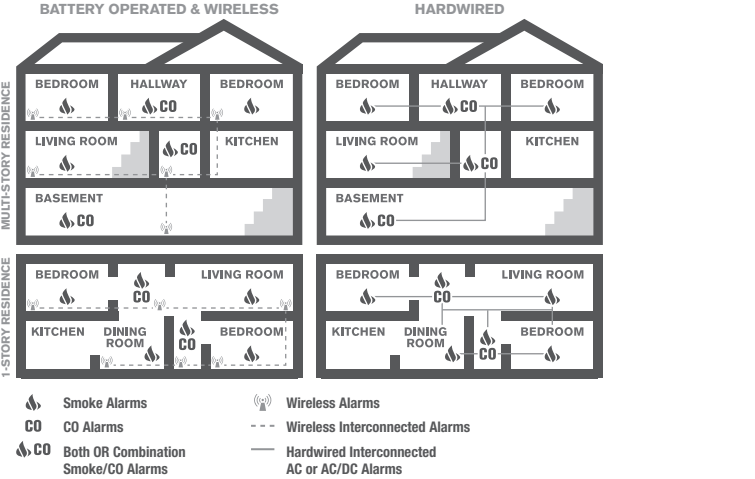

## 10 REGULATORY INFORMATION FOR CO ALARMS

### WHAT LEVELS OF CO CAUSE AN ALARM?

Underwriters Laboratories Inc. Standard UL2034 requires residential CO Alarms to sound when exposed to levels of CO and exposure times as described below. They are measured in parts per million (ppm) of CO over time (in minutes).

UL2034 Required Alarm Points\*:

- If the Alarm is exposed to 400 ppm of CO, IT MUST ALARM BETWEEN 4 and 15 MINUTES.
- If the Alarm is exposed to 150 ppm of CO, IT MUST ALARM BETWEEN 10 and 50 MINUTES.
- If the Alarm is exposed to 70 ppm if CO, IT MUST ALARM BETWEEN 60 and 240 MINUTES.

\*Approximately 10% COHb exposure at levels of 10% to 95% Relative Humidity (RH).

The unit is designed not to Alarm when exposed to a constant level of 30 ppm for 30 days.

### IMPORTANT!

CO Alarms are designed to Alarm before there is an immediate life threat. Since you cannot see or smell CO, never assume it's not present.

- An exposure to 100 ppm of CO for 20 minutes may not affect average, healthy adults, but after 4 hours the same level may cause headaches.
- An exposure to 400 ppm of CO may cause headaches in average, healthy adults after 35 minutes, but can cause death after 2 hours.

**Standards:** Underwriters Laboratories Inc. Single and Multiple Station Carbon Monoxide Alarms UL2034.

According to Underwriters Laboratories Inc. UL2034, Section 1-1.2: "Carbon monoxide Alarms covered by these requirements are intended to respond to the presence of carbon monoxide from sources such as, but not limited to, exhaust from internal-combustion engines, abnormal operation of fuel-fired appliances, and fireplaces. CO Alarms are intended to Alarm at carbon monoxide levels below those that could cause a loss of ability to react to the dangers of carbon monoxide exposure." This CO Alarm monitors the air at the Alarm, and is designed to Alarm before CO levels become life threatening. This allows you precious time to leave the house and correct the problem. This is only possible if Alarms are located, installed, and maintained as described in this manual.

**Gas Detection at Typical Temperature and Humidity Ranges:** The CO Alarm is not formulated to detect CO levels below 30 ppm (MIL) UL tested for false Alarm resistance to Methane (500 ppm), Butane (300 ppm), Heptane (500 ppm), Ethyl Acetate (200 ppm), Isopropyl Alcohol (200 ppm) and Carbon Dioxide (5000 ppm). Values measure gas and vapor concentrations in parts per million.

**Audible Alarm:** 85 dB minimum at 10 feet (3 meters).

## 11 AGENCY PLACEMENT RECOMMENDATIONS

**Standards:** Underwriters Laboratories Inc. Single and Multiple Station Smoke Alarms 217.

**NFPA 72 CHAPTER 29 "FOR YOUR INFORMATION, THE NATIONAL FIRE ALARM AND SIGNALING CODE, NFPA 72, READS AS FOLLOWS:"**

29.5.1\* Required Detection. 29.5.1.1\* Where required by other governing laws, codes, or standards for a specific type of occupancy, approved single and multiple-station Smoke Alarms shall be installed as follows:

- "In all sleeping rooms and guest rooms
- "Outside of each separate dwelling unit sleeping area, within 21 ft (6.4 m) of any door to a sleeping room, with the distance measured along a path of travel
- On every level of a dwelling unit, including basements
- On every level of a residential board and care occupancy (small facility), including basements and excluding crawl spaces and unfinished attics
- "In the living area(s) of a guest suite
- In the living area(s) of a residential board and care occupancy (small facility)

(Reprinted with permission from NFPA 72®, National Fire Alarm and Signaling Code Copyright © 2012 National Fire Protection Association, Quincy, MA 02269. This reprinted material is not the complete and official position of the National Fire Protection Association, on the referenced subject which is represented only by the standard in its entirety).

(National Fire Alarm and Signaling Code® and NFPA 72® are registered trademarks of the National Fire Protection Association, Inc., Quincy, MA 02269).

### CALIFORNIA STATE FIRE MARSHAL (CSFM)

Early warning detection is best achieved by the installation of fire detection equipment in all rooms and areas of the household as follows: A Smoke Alarm installed in each separate sleeping area (in the vicinity, but outside bedrooms), and Heat or Smoke Alarms in the living rooms, dining rooms, bedrooms, kitchens, hallways, finished attics, furnace rooms, closets, utility and storage rooms, basements, and attached garages.

## 12 SPECIAL COMPLIANCE CONSIDERATIONS

This Smoke Alarm is suitable for use in apartments, condominiums, townhouses, hospitals, day care facilities, health care facilities, boarding houses, group homes and dormitories provided a primary fire detection system already exists to meet fire detection requirements in common areas like lobbies, hallways, or porches. Using this Smoke Alarm in common areas may not provide sufficient warning to all residents or meet local fire protection ordinances/regulations.

This Smoke Alarm alone is not a suitable substitute for complete fire detection systems in places housing many people—like apartment buildings, condominiums, hotels, motels, dormitories, hospitals, health care facilities, nursing homes, day care facilities, or group homes of any kind. It is not a suitable substitute for complete fire detection systems in warehouses, industrial facilities, commercial buildings, and special-purpose non-residential buildings which require special fire detection and Alarm systems. Depending on the building codes in your area, this Smoke Alarm may be used to provide additional protection in these facilities.

In new construction, most building codes require the use of AC or AC/DC powered Smoke Alarms only. In existing construction, AC, AC/DC, or DC powered Smoke Alarms can be used as specified by local building codes. THIS EQUIPMENT SHOULD BE INSTALLED IN ACCORDANCE WITH THE NATIONAL FIRE PROTECTION ASSOCIATION'S STANDARD 72 (National Fire Protection Association, Batterymarch Park, Quincy, MA 02269). Refer to NFPA 101 (Life Safety Code), local building codes, or consult your Fire Department for detailed fire protection requirements in buildings not defined as "households".

### HUD MAP PROGRAM

Certain HUD battery powered Smoke Alarm applications, especially those that fall under HUD 223(f) MAP (Multi-family Accelerated Processing), may require a 10-Year sealed tamper resistant battery. This Alarm does not meet that requirement. Substitute FirstAlert SA340B.

### FCC COMPLIANCE

This equipment has been tested and found to comply with the limits for a Class B digital device, pursuant to Part 15 of the FCC rules. These limits are designed to provide reasonable protection against harmful interference in a residential installation. This equipment generates, uses and can radiate radio frequency energy and, if not installed and used in accordance with the instructions, may cause harmful interference to radio communications.

However, there is no guarantee that the interference will not occur in a particular installation. If this equipment does cause harmful interference to radio or television reception, which can be determined by turning the equipment off and on, the user is encouraged to try to correct the interference by one or more of the following measures:

- Reorient or relocate the receiving antenna.
- Increase the separation between the equipment and receiver.
- Connect the equipment into an outlet on a circuit different from that of the receiver.
- Consult the dealer or an experienced radio or TV technician for help.

### ▲ WARNING!

Changes or modifications to the product, not expressly approved by First Alert, could void the user's authority to operate the equipment.

This device complies with Part 15 of the FCC Rules. Operation is subject to the following two conditions: (1) this device may not cause harmful interference, and (2) this device must accept any interference received, including interference that may cause undesired operation.

## 13 GENERAL LIMITATIONS OF SMOKE/GO ALARMS

**This Smoke/CO Alarm is intended for residential use.** It is not intended for use in industrial applications where Occupational Safety and Health Administration (OSHA) requirements for Carbon Monoxide Alarms must be met. The Smoke Alarm portion of this device is not intended to alert hearing impaired residents. Special purpose Smoke Alarms should be installed for hearing impaired residents (CO Alarms are not yet available for the hearing impaired).

**Smoke/CO Alarms may not waken all individuals.** Practice the escape plan at least twice a year, making sure that everyone is involved – from kids to grandparents. Allow children to master fire escape planning and practice before holding a fire drill at night when they are sleeping. If children or others do not readily waken to the sound of the Smoke/CO Alarm, or if there are infants or family members with mobility limitations, make sure that someone is assigned to assist them in fire drill and in the event of an emergency. It is recommended that you hold a fire drill while family members are sleeping in order to determine their response to the sound of the Smoke/CO Alarm while sleeping and to determine whether they may need assistance in the event of an emergency.

**Smoke/CO Alarms cannot work without power.** Battery operated units cannot work if the batteries are missing, disconnected or dead, if the wrong type of batteries are used, or if the batteries are not installed correctly. AC units cannot work if the AC power is cut off for any reason (open fuse or circuit breaker, failure along a power line or at a power station, electrical fire that burns the electrical wires, etc. ). If you are concerned about the limitations of battery or AC power, install both types of units.

**This Smoke/CO Alarm will not sense smoke or CO that does not reach the sensors.** It will only sense smoke or CO at the sensor. **Smoke or CO may be present in other areas.** Doors or other obstructions may affect the rate at which CO or smoke reaches the sensors. If bedroom doors are usually closed at night, we recommend you install an Alarm device (Combination CO and Smoke Alarm, or separate CO Alarms and Smoke Alarms) in each bedroom and in the hallway between them.

**This Smoke/CO Alarm may not sense smoke or CO on another level of the home.** Example: This Alarm device, installed on the second floor, may not sense smoke or CO in the basement. For this reason, one Alarm device may not give adequate early warning. Recommended minimum protection is one Alarm device in every sleeping area, every bedroom, and on every level of your home. Some experts recommend battery powered smoke and CO Alarms be used in conjunction with interconnected AC powered Smoke Alarms. For details, see "About Smoke Alarms" for details.

**Smoke/CO Alarms may not be heard.** The Alarm horn loudness meets or exceeds current UL standards of 85 dB at 10 feet (3 meters). However, if the Smoke/CO Alarm is installed outside the bedroom, it may not wake up a sound sleeper or one who has recently used drugs or has been drinking alcoholic beverages. This is especially true if the door is closed or only partly open. Even persons who are awake may not hear the Alarm horn if the sound is blocked by distance or closed doors. Noise from traffic, stereo, radio, television, air conditioner, or other appliances may also prevent alert persons from hearing the Alarm horn. This Smoke/CO Alarm is not intended for people who are hearing impaired.

**The Alarm may not have time to Alarm before the fire itself causes damage, injury, or death, since smoke from some fires may not reach the unit immediately. Examples of this include persons smoking in bed, children playing with matches, when a person's clothing catches fire while cooking, fires caused by violent explosions resulting from escaping gas, or incendiary fires where the fire grows so rapidly that an occupant's egress is blocked even with properly located Smoke Alarms.**

**This Smoke/CO Alarm is not a substitute for life insurance.** Though this Smoke/CO Alarm warns against increasing CO levels or the presence of smoke, First Alert does not warrant or imply in any way that they will protect lives. Homeowners and renters must still insure their lives.

**This Smoke/CO Alarm is not foolproof.** Like all other electronic devices, this Smoke/CO Alarm has limitations. It can only detect smoke or CO that reaches the sensors. It may not give early warning of the source of smoke or CO in a remote part of the home, away from the Alarm device.

**This Smoke/CO Alarm has a limited life.** Although this Smoke/CO Alarm and all of its parts have passed many stringent tests and are designed to be as reliable as possible, any of these parts could fail at any time. Therefore, you must test this device weekly. The unit should be replaced immediately if it is not operating properly.

## 14 LIMITED WARRANTY

First Alert® warrants that for a period of ten years from the date of purchase, this product will be free from defects in material and workmanship. First Alert, at its option, will repair or replace this product or any component of the product found to be defective during the warranty period. Replacement will be made with a new or remanufactured product or component. If the product is no longer available, replacement may be made with a similar product of equal or greater value. This is your exclusive warranty.

This warranty is valid for the original retail purchaser from the date of initial retail purchase and is not transferable. Keep the original sales receipt. Proof of purchase is required to obtain warranty performance. First Alert dealers, service centers, or retail stores selling First Alert products do not have the right to alter, modify or any way change the terms and conditions of this warranty.

This warranty does not cover normal wear of parts or damage resulting from any of the following: negligent use or misuse of the product, use on improper voltage or current, use contrary to the operating instructions, disassembly, repair or alteration by anyone other than First Alert or an authorized service center. Further, the warranty does not cover Acts of God, such as fire, flood, hurricanes and tornadoes.

First Alert shall not be liable for any incidental or consequential damages caused by the breach of any express or implied warranty. Except to the extent prohibited by applicable law, any implied warranty of merchantability or fitness for a particular purpose is limited in duration to the duration of the above warranty. Some states, provinces or jurisdictions do not allow the exclusion or limitation of incidental or consequential damages or limitations on how long an implied warranty lasts, so the above limitations or exclusion may not apply to you. This warranty gives you specific legal rights, and you may also have other rights that vary from state to state or province to province.

### HOW TO OBTAIN WARRANTY SERVICE

**Service:** If service is required, do not return the product to your retailer. In order to obtain warranty service, contact the Consumer Support Team at 1-800-323-9005. To assist us in serving you, please have the model number and date of purchase available when calling.

**Disposal:** Please follow local guidelines regarding the disposal or recycling of batteries and/or electronics.

The Alarm should be deactivated before disposal. See, "To Permanently Deactivate the Smoke/CO Alarm".

|  |   |
|--|---|
| <b>For your records, please record:</b>                | <b>Replace Alarm 10 years after installation.</b>   |
| <b>Date Purchased:</b> _____                           | <b>Please write the date in the space provided:</b> |
| <b>Where Purchased:</b> _____                          | _____ / _____ <b>Month/Year</b>                     |
| <b>Date Installed:</b> _____ / _____ <b>Month/Year</b> |   |

**The Alarm will also provide an audible End-of-Life Signal approximately 10 years after installation to remind you to replace the unit.**

**The End-of-Life Signal can be silenced for up to 2 days. Do not unplug or deactivate the Alarm until you get replacement.**

Printed in Mexico | M08-170692 REV B 02/23  
**CONFORMS TO UL STD 217 AND UL STD 2034**  
firstalert.com

**L** © 2023 Resideo Technologies, Inc. All rights reserved. These products are manufactured by Resideo Technologies, Inc. and its affiliates. 3901 Liberty Street, Aurora, IL 60504-8122. Consumer Support Team: (800) 323-9005 | firstalert.com